

Deck 2

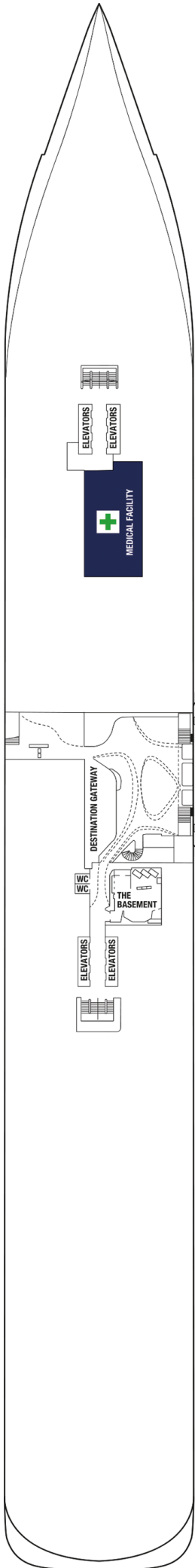

Deck 3

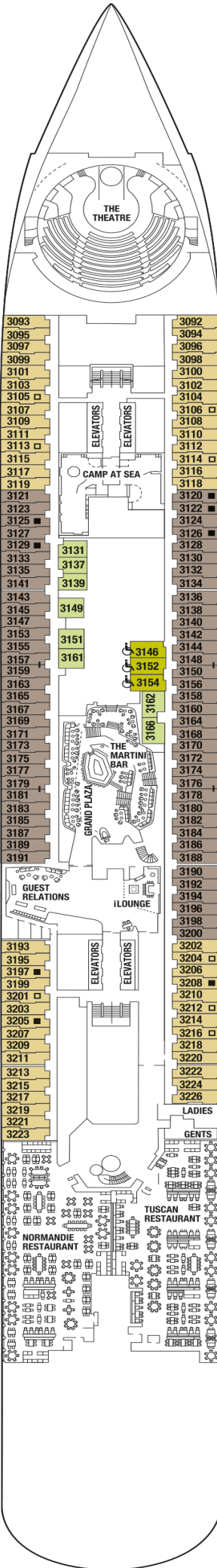

Deck 4

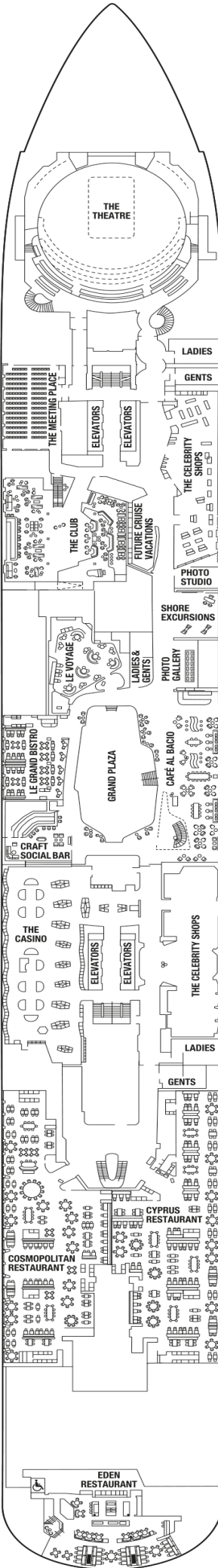

Deck 5

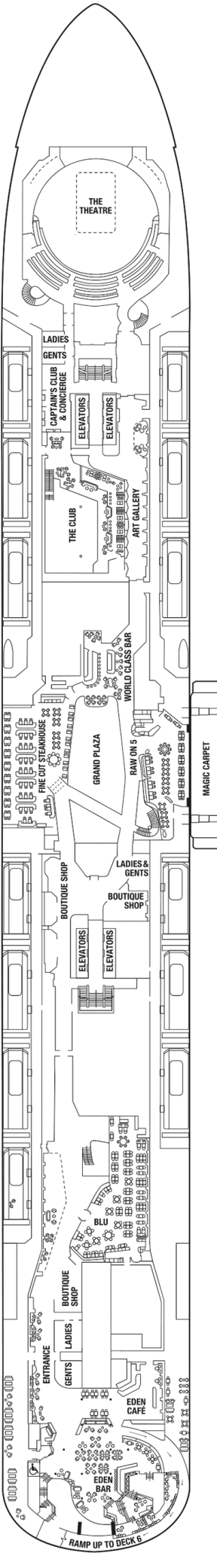

Deck 6

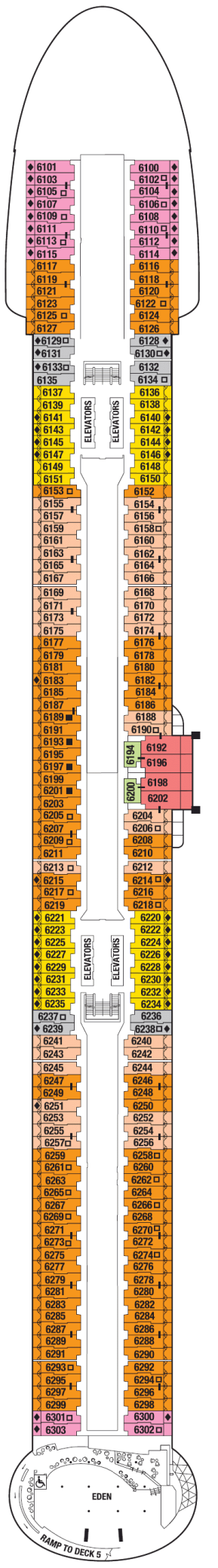

- 6101
- 6103
- 6105
- 6107
- 6109
- 6111
- 6113
- 6115
- 6117
- 6119
- 6121
- 6123
- 6125
- 6127
- 6129
- 6131
- 6133
- 6135
- 6137
- 6139
- 6141
- 6143
- 6145
- 6147
- 6149
- 6151
- 6153
- 6155
- 6157
- 6159
- 6161
- 6163
- 6165
- 6167
- 6169
- 6171
- 6173
- 6175
- 6177
- 6179
- 6181
- 6183
- 6185
- 6187
- 6189
- 6191
- 6193
- 6195
- 6197
- 6199
- 6201
- 6203
- 6205
- 6207
- 6209
- 6211
- 6213
- 6215
- 6217
- 6219
- 6221
- 6223
- 6225
- 6227
- 6229
- 6231
- 6233
- 6235
- 6237
- 6239
- 6241
- 6243
- 6245
- 6247
- 6249
- 6251
- 6253
- 6255
- 6257
- 6259
- 6261
- 6263
- 6265
- 6267
- 6269
- 6271
- 6273
- 6275
- 6277
- 6279
- 6281
- 6283
- 6285
- 6287
- 6289
- 6291
- 6293
- 6295
- 6297
- 6299
- 6301
- 6303
- 6100
- 6102
- 6104
- 6106
- 6108
- 6110
- 6112
- 6114
- 6116
- 6118
- 6120
- 6122
- 6124
- 6126
- 6128
- 6130
- 6132
- 6134
- 6136
- 6138
- 6140
- 6142
- 6144
- 6146
- 6148
- 6150
- 6152
- 6154
- 6156
- 6158
- 6160
- 6162
- 6164
- 6166
- 6168
- 6170
- 6172
- 6174
- 6176
- 6178
- 6180
- 6182
- 6184
- 6186
- 6188
- 6190
- 6192
- 6194
- 6196
- 6198
- 6200
- 6202
- 6204
- 6206
- 6208
- 6210
- 6212
- 6214
- 6216
- 6218
- 6220
- 6222
- 6224
- 6226
- 6228
- 6230
- 6232
- 6234
- 6236
- 6238
- 6240
- 6242
- 6244
- 6246
- 6248
- 6250
- 6252
- 6254
- 6256
- 6258
- 6260
- 6262
- 6264
- 6266
- 6268
- 6270
- 6272
- 6274
- 6276
- 6278
- 6280
- 6282
- 6284
- 6286
- 6288
- 6290
- 6292
- 6294
- 6296
- 6298
- 6300
- 6302

Deck 7

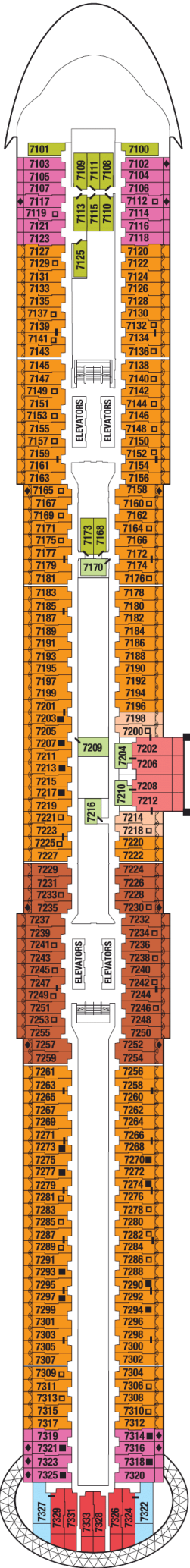

Deck 8

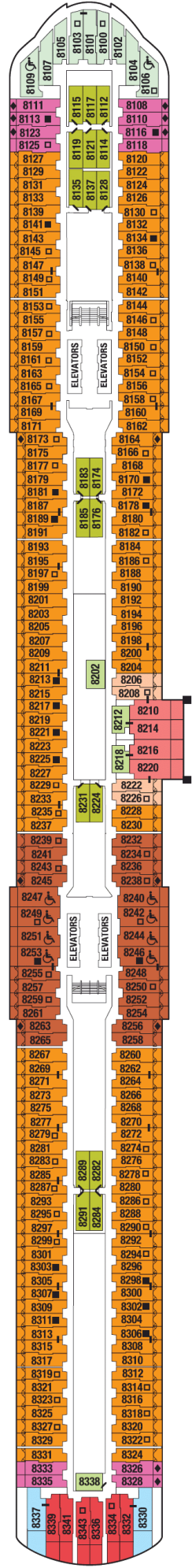

Deck 9

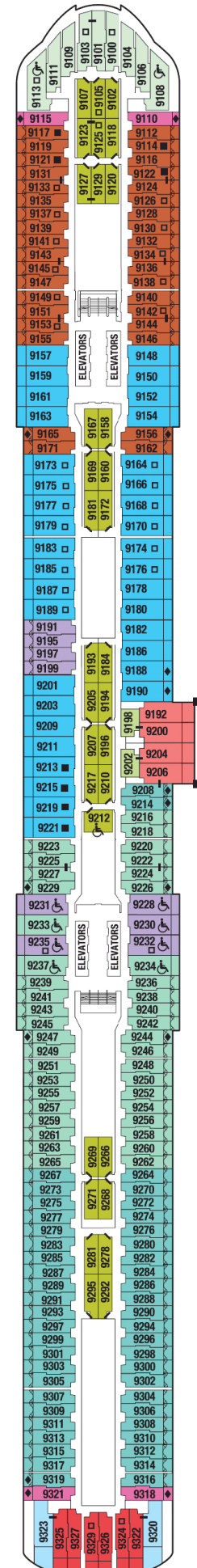

Deck 10

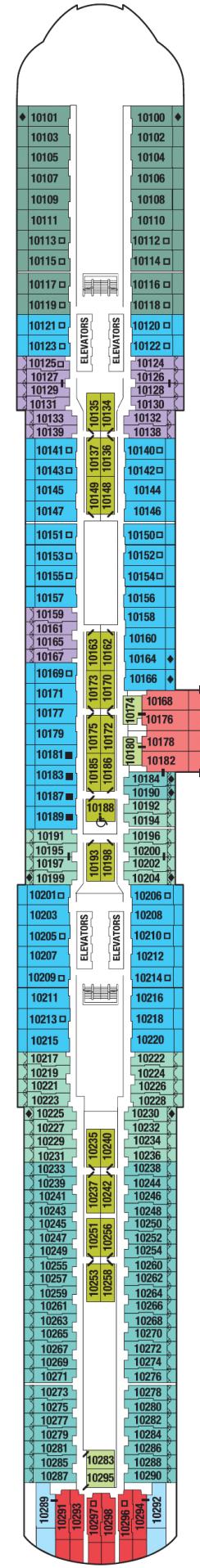

Deck 11

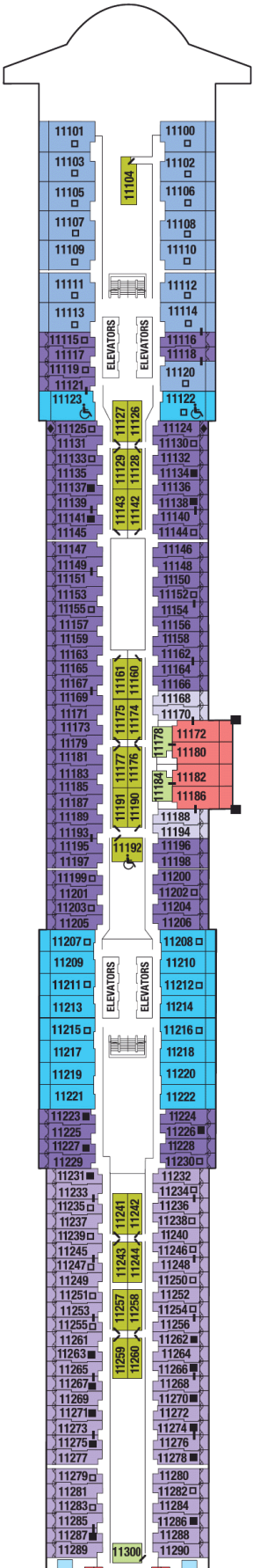

Deck 12

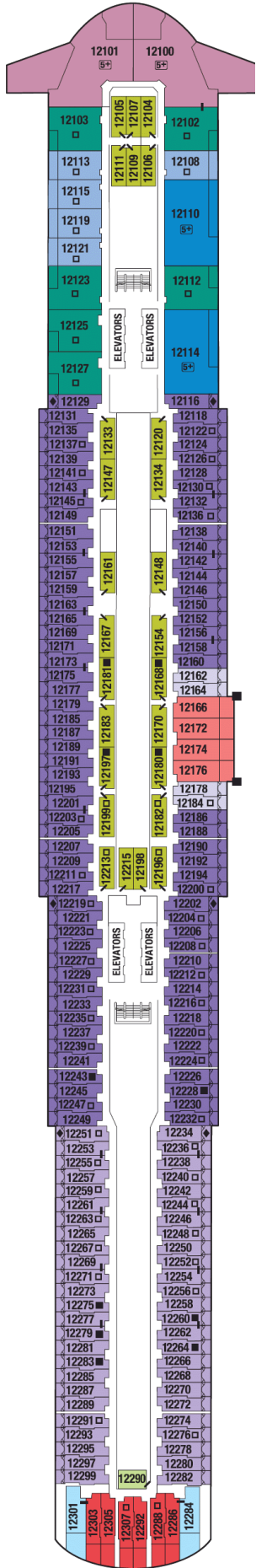

Deck 14

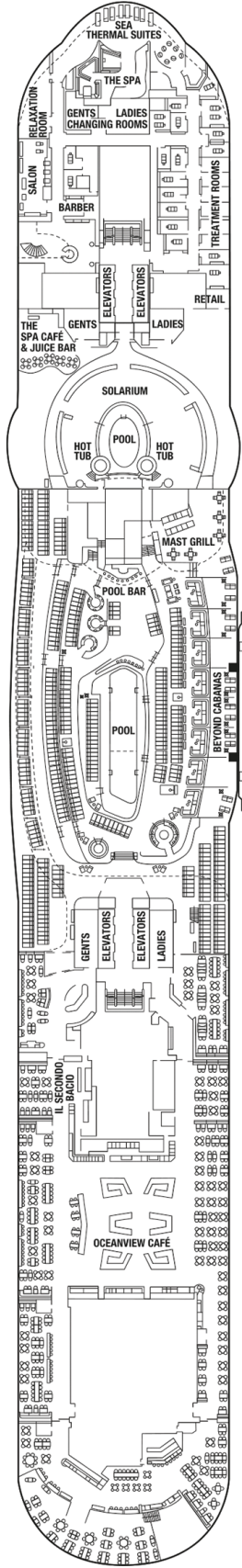

Deck 15

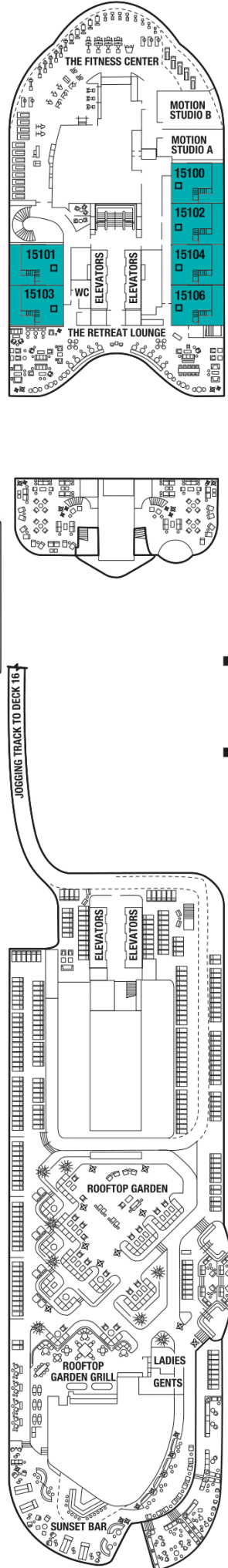

Deck 16

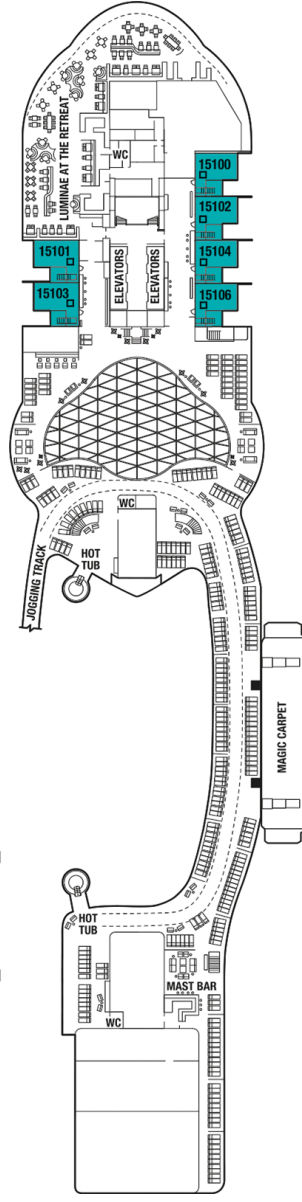

Deck 17

